



summer 2015



SiS Ergo

# over 45 years of height adjustable solutions

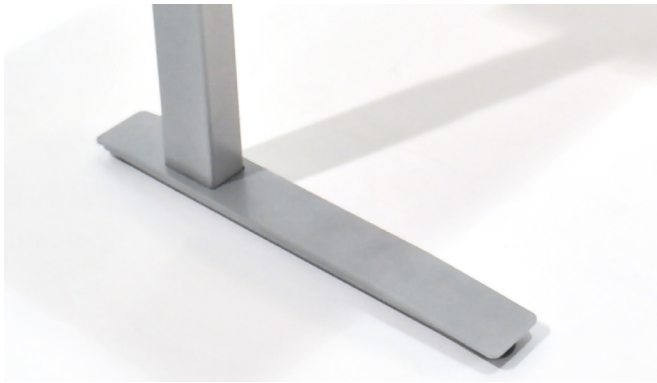

## *about us*

For over 45 years, SiS Ergo has been a pioneer in design and manufacturing of ergonomic solutions for all work environments. Using the Danish design concept of simplicity and functionality, SiS Ergo products can be seamlessly integrated into any type of workspace. As a company, we are constantly reinventing and improving upon our designs to provide the best solutions for the ever-changing economic, environmental and ergonomic needs of today's workplace. Research has shown the multiple health benefits of sit-to-stand desks. SiS Ergo is proud to work with companies that are mindful of the well-being of their employees while providing energized and flexible spaces for maximum productivity.

## *global manufacturing*

SiS Ergo is an international company with manufacturing facilities in Denmark and New Hampshire and a showroom at the Merchandise Mart in Chicago, Illinois. Our facilities are fitted with state-of-the-art equipment that ensures the highest quality of finished product, as well as the health and safety of our employees.

### *Denmark*



### *New Hampshire*



### *Chicago Showroom at the Merchandise Mart*





### *environmentally friendly*

It is SiS Ergo’s policy to continuously reduce the environmental impact of our products and processes. We seek to achieve this through better use of raw materials and energy and by optimizing our production processes. We use and manufacture sustainable products that rely less on synthetic materials, minimize components and production steps, and can be recycled and reused to allow for a positive impact on the overall product life-cycle.

SiS Ergo requires that all of our vendors, both local and offshore, adhere to a Chain of Supply Code of Ethics. Globalization has made us increasingly interdependent, and we inform new suppliers about safety, fair wage and environmental issues that are important to us.

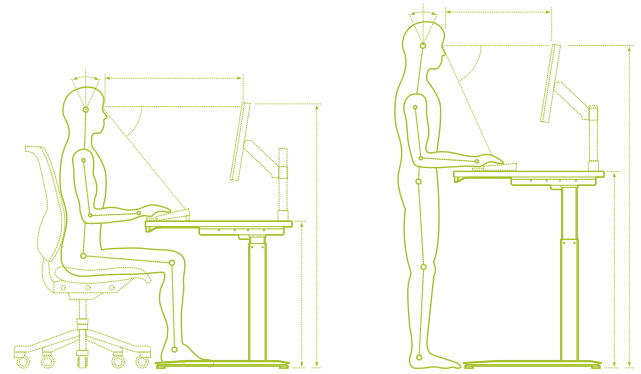

### *ANSI/BIFMA/UL*

The American National Standards Institute (ANSI) oversees the creation, promulgation and use of thousands of guidelines that directly impact businesses in every sector. ANSI is also actively engaged in accrediting programs that assess conformance to standards management systems.

Business and Institutional Furniture Manufacturers Association (BIFMA) is the standards body used by manufacturers of business and institutional furnishings to create and comply with U.S. standards, under the ANSI umbrella.

All tables meet or exceed ANSI/BIFMA qualifications.

The SX, SXL, SE and SEL products are all ETL listed to UL 962 for Household and Commercial Furnishings.







*SiS Ergo adjustable solutions are designed to meet the needs of every employee. By focusing on our product's ergonomic, flexible and cost-effective design, we are able to manufacture furniture that is superior in today's market.*

## ergonomics & employee health

Because people come in so many shapes and sizes, setting workspace standards is no easy task. Sitting at workstations that are too low or too high affects a person's ability to concentrate. Research shows that people are more productive and healthier when working with comfortable, flexible workstations that allow them to move and keep energized.

## durable

Our goal at SiS Ergo is to maintain high standards of quality. SiS Ergo products are carefully designed, well built and thoroughly tested before they go to market. SiS Ergo is committed to providing high quality products by continuously investing significant resources in production and product development.

## flexible

People are most comfortable when they work in neutral postures and are most productive when they are comfortable. Movement is an important key to work activity as it activates the body's muscle pump, increasing circulation and keeping the body energized.

## eco-responsible

With several adjustable solutions that require no electricity, SiS Ergo is committed to manufacturing and designing solutions that are environmentally friendly. All electric actuators are PVC free and maintain industry-leading 0.1 W standby power for optimal energy efficiency.

## cost-effective

All SiS Ergo workstations are backed with an industry-leading warranty! The reality that organizations face today is one of limited resources for a future of limitless change. Office equipment and furnishings must support a range of changing requirements that guarantee a return on investment.





The S Collection incorporates Danish design with the most comprehensive selection of height-adjustable tables in the industry. It represents over 45 years of craftsmanship and functionality that enhances new or existing workstations.

- Base-only applications that can retrofit new or existing workstations
- Pin, crank and electric frames with vertical and horizontal adjustment for maximum flexibility
- 2, 3 and 4 leg options
- Standard base colors include silver, black and white. Custom color selections are also available
- Hidden but flexible crossbar options allow flexibility through field adjustment
- Surface designs in any shape allow for ultimate flexibility

# S collection product line

## SX enhanced electric

Height Range\*: 22.1" – 48.6"

The SX series offers the maximum sit-to-stand workstation adjustment in the S collection from 22.1" - 48.6". It meets the ANSI/BIFMA recommended range—fitting the 5<sup>th</sup> percentile female and 95<sup>th</sup> percentile male—so more people can work more comfortably and productively.

## SXL enhanced electric

Height Range\*: 22.1" – 48.6"

The SXL offers the same 22.1" - 48.6" height adjustability range as the SX and is a great value for those looking to meet the ANSI-BIFMA requirements with two leg configurations and lower weight capacity.

### SX2

Weight Capacity\*\*: 350 lbs.



### SXL2

Weight Capacity\*\*: 200 lbs.



### SX3

Weight Capacity\*\*: 525 lbs.



### SXV3

Weight Capacity\*\*: 525 lbs.

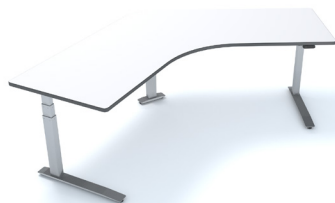



## SE electric

Height Range\*: 27" – 46.5"

The SE series incorporates the design, weight capacity and quality of SX with a modified sit-to-stand range of 27" - 46.5".

## SEL electric

Height Range\*: 27" – 46.5"

The SEL offers the design and quality of SX with the modified sit-to-stand range of the SE, 27" - 46.5". The SEL is a value option for those who require two leg configurations with lower weight capacities.

### SE2

Weight Capacity\*\*: 350 lbs.



### SEL2

Weight Capacity\*\*: 200 lbs.



### SE3

Weight Capacity\*\*: 525 lbs.



### SEV3

Weight Capacity\*\*: 525 lbs.

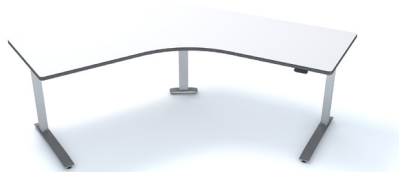

\* All height ranges include 1" thick surface

\*\* Maximum table frame capacity

# s collection product line

## SC crank

Height Range\*: 23" – 36"

The simple turn of the crank handle on the SC series offers smooth and adaptable seated adjustment. Crank handles are positioned at a location free from obstruction and can retract to eliminate any obstruction in the space.

### SC2

Weight Capacity\*\*: 264 lbs.



### SC3

Weight Capacity\*\*: 375 lbs.

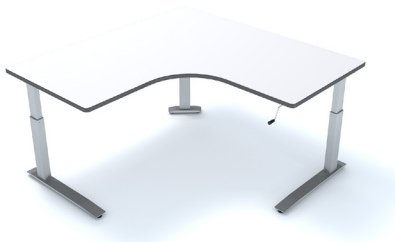

### SCV3

Weight Capacity\*\*: 375 lbs.

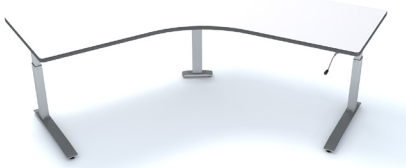

## SP pin

Height Range\*: 23" – 36"

Pin operation on the SP series adjusts via extension and retraction of the inner leg tube. The ruler on the side of the table leg ensures ease of leveling along with accurate accommodations that can be individualized to each user.

### SP2

Weight Capacity\*\*: 440 lbs.



### SP3

Weight Capacity\*\*: 660 lbs.



## SF fixed

Height Range\*: 28"

The SF series has been designed to seamlessly integrate with any of the S collection bases. As a base companion it offers a true color and design match that will ensure a complete and finished look for any project.

### SF2

Weight Capacity\*\*: 440 lbs.



### SF3

Weight Capacity\*\*: 660 lbs.

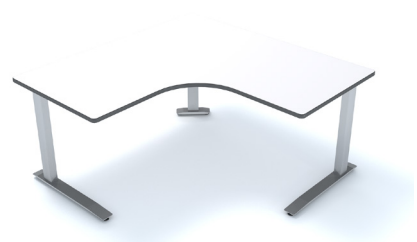

\* All height ranges include 1" thick surface

\*\* Maximum table frame capacity

## s collection overview

Specifications	SX	SXL	SE	SEL
Height Range (with 1" worksurface)	22.1" - 48.6"	22.1" - 48.6"	27" - 46.5"	27" - 46.5"
Weight Load (per leg)	350 lbs. (175 lbs. per leg)	200 lbs. (100 lbs. per leg)	350 lbs. (175 lbs. per leg)	200 lbs. (100 lbs. per leg)
Adjustment Speed (per inch)	1.5" per second	1.5" per second	1.5" per second	1.5" per second
Work-surface Leg Configuration	1-4 legs	2 leg maximum	1-4 legs	2 leg maximum
Standard Color Options	Silver, Black & White	Silver, Black	Silver, Black & White	Silver, Black
National Electric Code Compliant	Yes	Yes	Yes	Yes
ETL Listed to UL 962	Yes	Yes	Yes	Yes

Optional Features Eligibility	SX	SXL	SE	SEL
Bluetooth Upgrade Eligability	✓	✗	✓	✗
Anti-collision Upgrade	✓	✗	✓	✗
Height Range Lockout	✓	✗	✓	✗
Battery Operation Converter	✓	✗	✓	✗
Software Progamability	✓	✗	✓	✗
Up/Down Switch	✓	✓	✓	✓
Non-digital Memory Switch	✓	✓	✓	✓
Digital Memory Switch	✓	✓	✓	✓



### Up/Down Control Switch

Model # UD

This switch is the default switch.



### Upgradeable Non-digital Control Switch

Model # MS

Programmable switch with 3 memory presets



### Upgradeable Digital Control Switch

Model # DS

Programmable switch with 3 memory presets and a digital height display

# ordering information

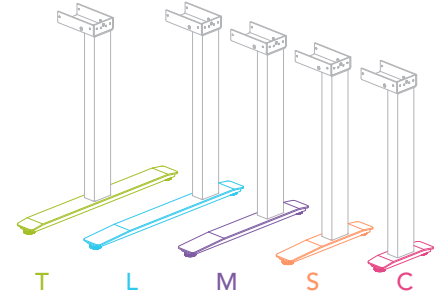
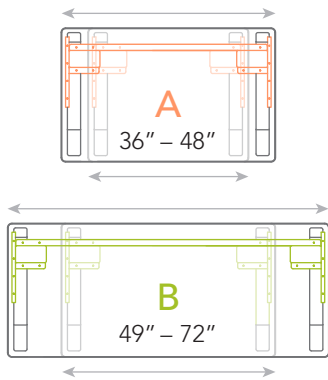

## width options

The adjustable crossbar adds a new dimension to reconfiguration through field adjustments. It reduces the cost while expanding the design options.

## color options

Standard, ready-to-ship frame colors include silver, black and white. Custom colors are also available.

## foot options

Variety of sizes allows for maximum stability for every application.

## foot options

Feet Variations	Foot Length	Table Depth Options	Product Code
10" center	9.85" (250mm)	N/A (center legs only)	C
17" cantilevered	15.76" (400mm)	17" - 30" (3-leg table return only)	S
24" cantilevered	21.56" (547.6mm)	22" - 27"	M
30" cantilevered	27.56" (700mm)	28" - 36"	L
30" conference (T-foot)	27.56" (700mm)	28" - 50"	T



### frame only ordering information

**Select Product Name** – Specify product name to determine height adjustability. See pages 8-10 for options.

**Select Frame Model** – Obtain model information from charts on pages 14-18 based on desired dimensions.

**Select Frame Color** – Specify **B** (black), **W** (white) or **S** (silver).

**Select Switch** – For SX, SXL, SE and SEL models, specify **UD** (up/down switch), **MS** (non-digital), **DS** (digital).

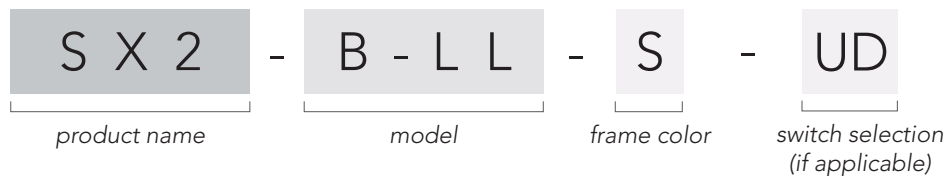

### frame and worksurface ordering information

**Select Product Name** – Specify product name to determine height adjustability. See pages 8-10 for options.

**Select Frame Model** – Obtain model information from charts on pages 14-18 based on desired dimensions.

**Select Frame Color** – Specify **B** (black), **W** (white) or **S** (silver).

**Select Surface Laminate** – Specify laminate choice from our list of favorites. See page 27 for options.

**Select Edge Color** – Specify edge color. See page 27 for options.

**Select Switch** – For SX, SXL, SE and SEL models, specify **UD** (up/down switch), **MS** (non-digital), **DS** (digital).

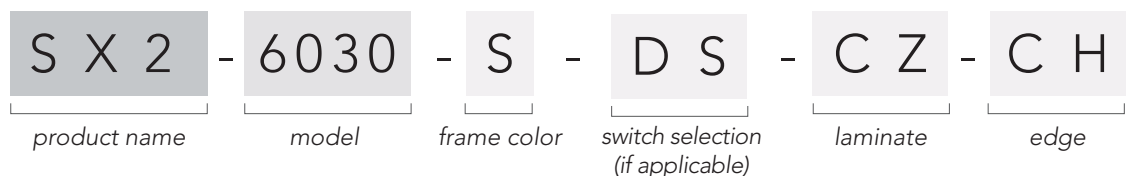

**Lead Time** – 4-6 weeks from receipt of order for standard items

# rectilinear worksurface

## 2 leg rectilinear frame only

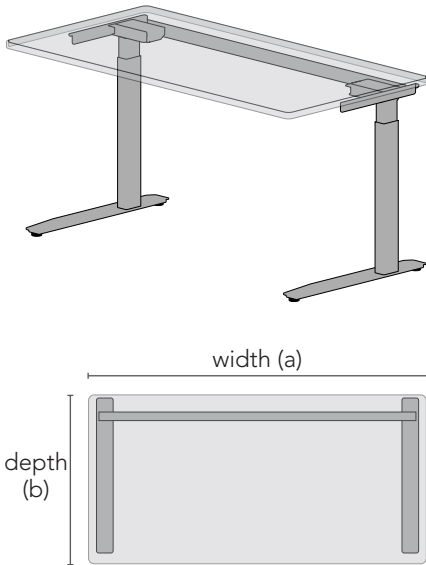

Model	List Price						Dimensions	
	SX2	SXL2	SE2	SEL2	SC2	SP2	Width Range (a)	Depth Range (b)
A-MM	\$2,099	\$1,699	\$1,599	\$1,299	\$1,199	\$1,049	36" - 48"	22" - 27"
A-LL	2,149	1,749	1,649	1,349	1,249	1,099	36" - 48"	28" - 30"
A-TT	2,149	1,749	1,649	1,349	1,249	1,099	36" - 48"	28" - 30"
B-MM	2,199	1,799	1,699	1,399	1,299	1,149	49" - 72"	22" - 27"
B-LL	2,249	1,849	1,749	1,449	1,349	1,199	49" - 72"	28" - 30"
B-TT	2,249	1,849	1,749	1,449	1,349	1,199	49" - 72"	28" - 30"

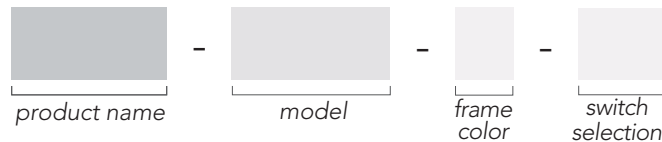

## 2 leg rectilinear frame and worksurface

Model	List Price							Actual Dimensions	
	SX2	SXL2	SE2	SEL2	SC2	SP2	SF2	Width (a)	Depth (b)
3624	\$2,299	\$1,899	\$1,799	\$1,549	\$1,499	\$1,249	\$949	36"	24"
4224	2,349	1,949	1,849	1,549	1,549	1,299	999	42"	24"
4824	2,399	1,999	1,899	1,599	1,599	1,349	1,049	48"	24"
5424	2,449	2,099	1,949	1,699	1,649	1,399	1,099	54"	24"
6024	2,499	2,099	1,999	1,699	1,699	1,449	1,149	60"	24"
6624	2,549	2,149	2,049	1,749	1,749	1,499	1,199	66"	24"
7224	2,599	2,149	2,049	1,749	1,749	1,549	1,249	72"	24"
3630	2,449	1,999	1,949	1,599	1,599	1,349	1,049	36"	30"
3630T	2,449	1,999	1,949	1,599	1,599	1,349	1,049	36"	30"
4230	2,499	1,999	1,949	1,599	1,649	1,399	1,099	42"	30"
4230T	2,499	1,999	1,949	1,599	1,649	1,399	1,099	42"	30"
4830	2,549	2,049	1,999	1,649	1,699	1,449	1,149	48"	30"
4830T	2,549	2,049	1,999	1,649	1,699	1,449	1,149	48"	30"
5430	2,599	2,149	1,999	1,749	1,749	1,499	1,199	54"	30"
5430T	2,599	2,149	1,999	1,749	1,749	1,499	1,199	54"	30"
6030	2,649	2,199	2,049	1,799	1,799	1,549	1,249	60"	30"
6030T	2,649	2,199	2,049	1,799	1,799	1,549	1,249	60"	30"
6630	2,649	2,199	2,049	1,799	1,799	1,599	1,299	66"	30"
6630T	2,649	2,199	2,049	1,799	1,799	1,599	1,299	66"	30"
7230	2,749	2,199	2,099	1,799	1,799	1,649	1,349	72"	30"
7230T	2,749	2,199	2,099	1,799	1,799	1,649	1,349	72"	30"



# corner worksurface

## 2 leg equal corner frame only

Model	List Price						Dimensions	
	SX2	SXL2	SE2	SEL2	SC2	SP2	Width Range (a)	Depth Range (b)
A-MM	\$2,099	\$1,699	\$1,599	\$1,249	\$1,199	\$1,049	40" - 48"	22" - 27"
A-LL	2,149	1,749	1,649	1,349	1,249	1,099	49" - 54"	28" - 30"
A-TT	2,149	1,749	1,649	1,349	1,249	1,099	49" - 54"	28" - 30"

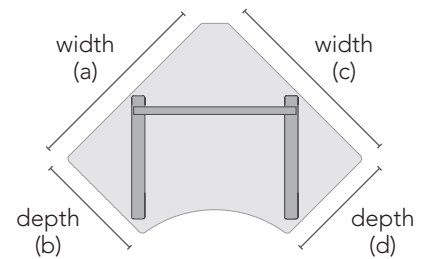
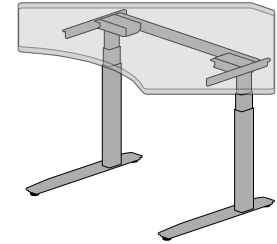
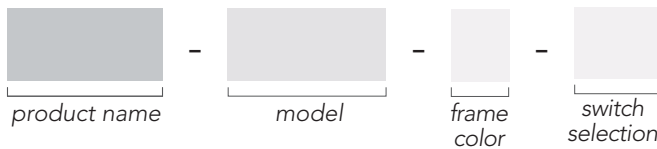

## 2 leg equal corner frame and worksurface

Model	List Price					Actual Dimensions			
	SX2	SXL2	SE2	SEL2	SC2	Width (a)	Depth (b)	Width (c)	Depth (d)
422	\$2,399	\$1,999	\$1,899	\$1,749	custom	42"	24"	42"	24"
462	2,449	2,049	1,949	1,799	custom	46"	24"	46"	24"
482	2,499	2,099	1,999	1,849	custom	48"	24"	48"	24"
423	2,479	2,079	1,979	1,829	custom	42"	30"	42"	30"
423T	2,479	2,079	1,979	1,829	custom	42"	30"	42"	30"
463	2,529	2,129	2,029	1,879	custom	46"	30"	46"	30"
463T	2,529	2,129	2,029	1,879	custom	46"	30"	46"	30"
483	2,579	2,179	2,079	1,929	custom	48"	30"	48"	30"
483T	2,579	2,179	2,079	1,929	custom	48"	30"	48"	30"

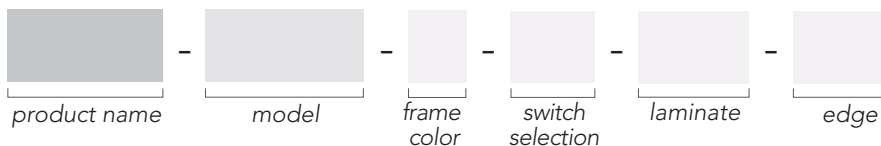

# 120° worksurface 2 leg

## 2 leg 120° frame only

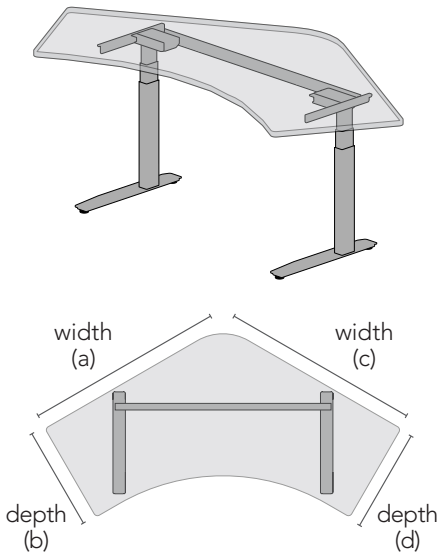

Model	List Price					Dimensions	
	SXV2	SXLV2	SEV2	SELV2	SCV2	Width Range (a)	Depth Range (b)
A-MM	\$2,099	\$1,699	\$1,599	\$1,299	\$1,199	36" - 41"	22" - 27"
A-LL	2,149	1,749	1,649	1,349	1,249	36" - 41"	28" - 30"
A-TT	2,149	1,749	1,649	1,349	1,249	36" - 41"	28" - 30"
B-MM	2,199	1,799	1,699	1,399	1,299	42" - 48"	22" - 27"
B-LL	2,249	1,849	1,749	1,449	1,349	42" - 48"	28" - 30"
B-TT	2,249	1,849	1,749	1,449	1,349	42" - 48"	28" - 30"

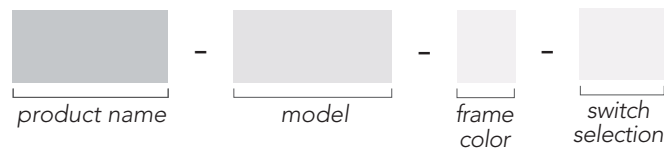

## 2 leg 120° frame and worksurface

Model	List Price					Actual Dimensions			
	SXV2	SXLV2	SEV2	SELV2	SCV2	Width (a)	Depth (b)	Width (c)	Depth (d)
362	\$2,549	\$2,149	\$2,049	\$1,899	\$1,649	36"	24"	36"	24"
422	2,699	2,299	2,199	2,049	1,799	42"	24"	42"	24"
482	2,749	2,349	2,249	2,099	1,849	48"	24"	48"	24"
363	2,629	2,229	2,129	1,979	1,729	36"	30"	36"	30"
363T	2,629	2,229	2,129	1,979	1,729	36"	30"	36"	30"
423	2,779	2,379	2,279	2,129	1,879	42"	30"	42"	30"
423T	2,779	2,379	2,279	2,129	1,879	42"	30"	42"	30"
483	2,829	2,429	2,329	2,179	1,929	48"	30"	48"	30"
483T	2,829	2,429	2,329	2,179	1,929	48"	30"	48"	30"

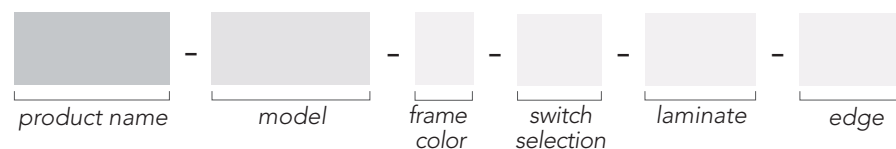



# 120° worksurface 3 leg

## 3 leg 120° frame only

Model	List Price			Dimensions	
	SXV3	SEV3	SCV3	Width Range (a)	Depth Range (b)
BB-MM-C	\$2,949	\$2,499	\$1,999	60" - 78"	22" - 27"
BB-LL-C	2,999	2,549	2,049	60" - 78"	28" - 30"

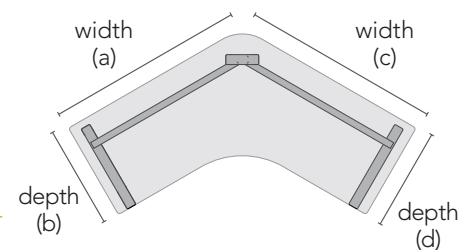
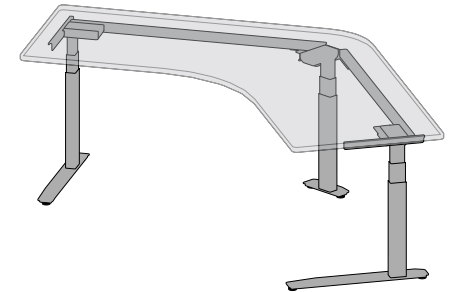

## 3 leg 120° frame and worksurface

Model	List Price			Actual Dimensions			
	SXV3	SEV3	SCV3	Width (a)	Depth (b)	Width (c)	Depth (d)
602	\$4,049	\$3,149	\$2,649	60"	24"	60"	24"
662	4,099	3,199	2,699	66"	24"	66"	24"
722	4,149	3,249	2,749	72"	24"	72"	24"
603	4,099	3,199	2,699	60"	30"	60"	30"
663	4,149	3,249	2,749	66"	30"	66"	30"
723	4,199	3,299	2,799	72"	30"	72"	30"

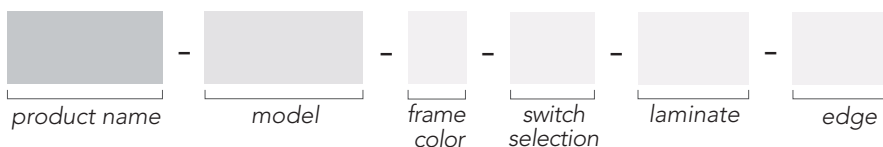

# 90° worksurface

## 3 leg 90° frame only

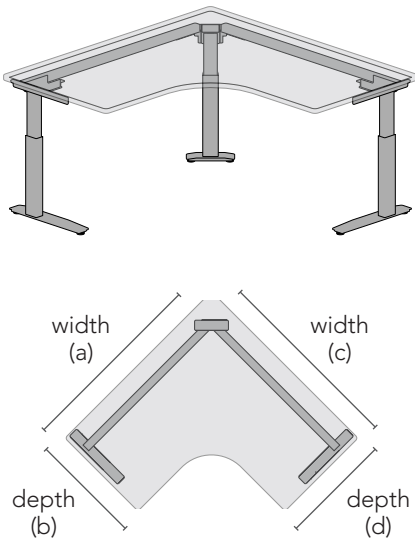

Model	List Price			Dimensions	
	SX3	SE3	SC3	Width Range (a)	Depth Range (b)
AA-SS-C	\$2,849	\$2,399	\$1,899	42" - 54"	22" - 30"
BB-SS-C	2,899	2,449	1,949	54" - 78"	22" - 30"

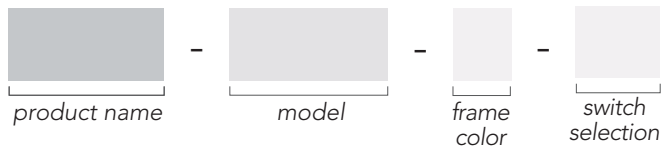

## 3 leg 90° frame and worksurface

Model	List Price					Actual Dimensions			
	SX3	SE3	SC3	SP3	SF3	Width (a)	Depth (b)	Width (c)	Depth (d)
482	\$3,349	\$3,049	\$2,649	\$1,499	\$1,249	48"	24"	48"	24"
542	3,399	3,099	2,699	1,549	1,299	54"	24"	54"	24"
602	3,449	3,149	2,749	1,599	1,349	60"	24"	60"	24"
662	3,499	3,199	2,799	1,649	1,399	66"	24"	66"	24"
722	3,549	3,249	2,849	1,699	1,449	72"	24"	72"	24"
483	3,649	3,149	2,749	1,599	1,349	48"	30"	48"	30"
543	3,699	3,199	2,799	1,649	1,399	54"	30"	54"	30"
603	3,749	3,249	2,849	1,699	1,449	60"	30"	60"	30"
663	3,799	3,299	2,899	1,749	1,499	66"	30"	66"	30"
723	3,849	3,349	2,949	1,799	1,549	72"	30"	72"	30"

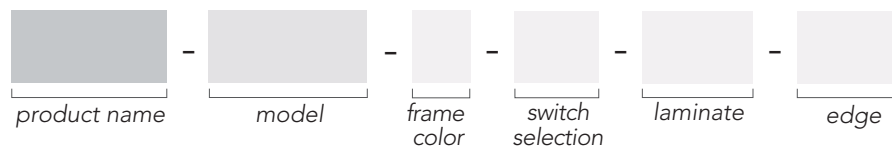









The M Series represents the fusion of minimalistic Danish design and constant force adjustment. As technology trends drive lighter task loads, the M Series becomes the more relevant ergonomic alternative to electric, counterbalance or pneumatic adjustable tables.

- Five floor base options for optimum stability
- Standard base colors include silver, black and white. Custom color selections are also available
- Safety brake with integrated locking mechanism to prevent inadvertent adjustment
- Task load specification ensures no end user calibration required
- Optional casters for added mobility to work virtually anywhere

# M series corner table

## 1 product name: MC

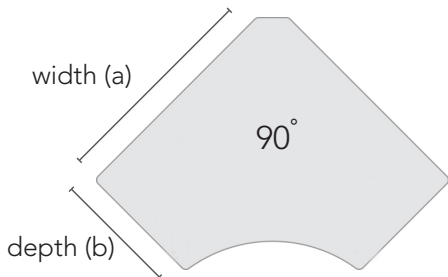

\*Actual sizes reflected below. Nominal sizes available to retrofit existing work stations. Please refer to customs on page 31.

## 2 model and floor base selection

Actual Dimensions		Top Weight (lbs.)	Model	Floor Base Options		
Width (a)	Depth (b)			LC	H	GW
36"	24"	37	362	\$1,449	n/a	n/a
36"	30"	39	363	1,479	n/a	n/a
42"	24"	48	422	1,499	\$1,499	n/a
42"	30"	52	423	1,529	1,529	n/a
48"	24"	60	482	n/a	1,549	\$1,599
48"	30"	65	483	n/a	1,579	1,629

\*\*List pricing above reflects top and frame.

## 3 worksurface task load



average monitor: 5-7 lbs.



average laptop: 5-10 lbs.



average monitor arm: 12-15lbs.



average tower CPU: 18-20 lbs.

## 4 column selection

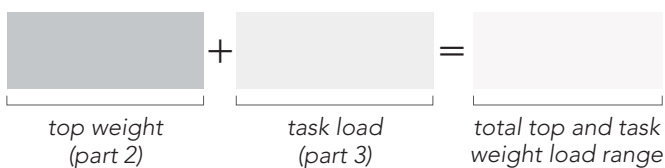

total top and task weight load range	column option
35-60 lbs.	L (Light)
61-80 lbs.	M (Medium)
81-105 lbs.	H (Heavy Duty)

## 5 my product

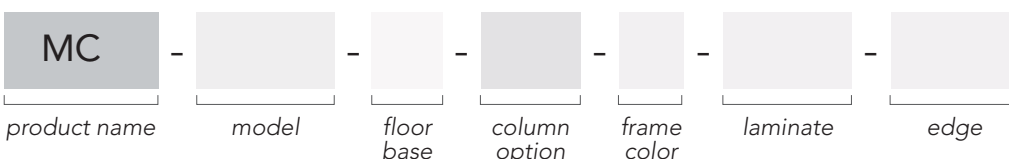

# M series 120° table

## 1 product name: MV

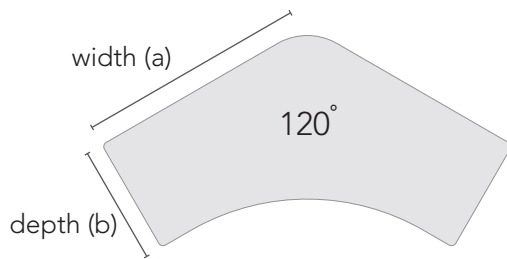

\*Actual sizes reflected below. Nominal sizes available to retrofit existing work stations. Please refer to customs on page 31.

## 2 model and floor base selection

Actual Dimensions		Top Weight (lbs.)	Model	Floor Base Options		
Width (a)	Depth (b)			 LC	 H	 GW
36"	24"	45	362	\$1,649	\$1,649	n/a
36"	30"	52	363	1,679	1,679	n/a
42"	24"	54	422	n/a	1,699	\$1,749
42"	30"	64	423	n/a	1,729	1,779
48"	24"	65	482	n/a	n/a	1,799
48"	30"	77	483	n/a	n/a	1,829

\*\*List pricing above reflects top and frame.

## 3 worksurface task load



average monitor: 5-7 lbs.



average laptop: 5-10 lbs.



average monitor arm: 12-15lbs.



average tower CPU: 18-20 lbs.

## 4 column selection

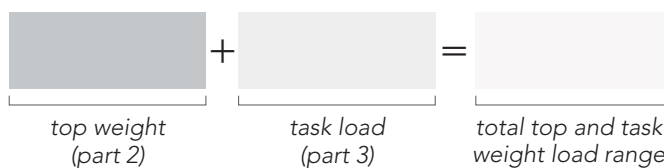

total top and task weight load range	column option
35-60 lbs.	L (Light)
61-80 lbs.	M (Medium)
81-105 lbs.	H (Heavy Duty)

## 5 my product

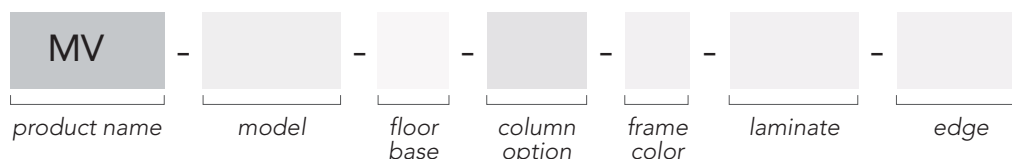





# M series rectilinear table

## 1 product name: MR



\*Actual sizes reflected below. Nominal sizes available to retrofit existing work stations. Please refer to customs on page 31.

## 2 model and floor base selection

Actual Dimensions		Top Weight (lbs.)	Model	Floor Base Options			
Width (a)	Depth (b)			 P	 SC	 H	 GW
30"	24"	22	3024	\$1,399	\$1,399	n/a	n/a
30"	30"	28	3030	1,429	1,429	n/a	n/a
36"	24"	27	3624	1,399	1,399	1,449	n/a
36"	30"	34	3630	1,429	1,429	1,479	n/a
42"	24"	31	4224	1,429	1,429	1,479	n/a
42"	30"	39	4230	n/a	1,459	1,509	n/a
48"	24"	36	4824	n/a	n/a	1,499	n/a
48"	30"	45	4830	n/a	n/a	1,529	n/a
54"	24"	40	5424	n/a	n/a	1,499	n/a
54"	30"	50	5430	n/a	n/a	1,529	n/a
60"	24"	45	6024	n/a	n/a	1,529	1,579
60"	30"	56	6030	n/a	n/a	1,559	1,609
66"	24"	49	6624	n/a	n/a	n/a	1,599
66"	30"	62	6630	n/a	n/a	n/a	1,629
72"	24"	54	7224	n/a	n/a	n/a	1,629
72"	30"	67	7230	n/a	n/a	n/a	1,659

\*\*List pricing above reflects top and frame.

### 3 worksurface task load



average monitor: 5-7 lbs.



average laptop: 5-10 lbs.



average monitor arm: 12-15lbs.



average tower CPU: 18-20 lbs.

### 4 column selection

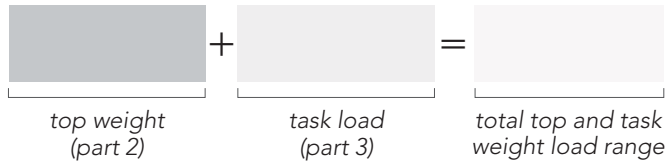

total top and task weight load range	column option
35-60 lbs.	L (Light)
61-80 lbs.	M (Medium)
81-105 lbs.	H (Heavy Duty)

### 5 my product

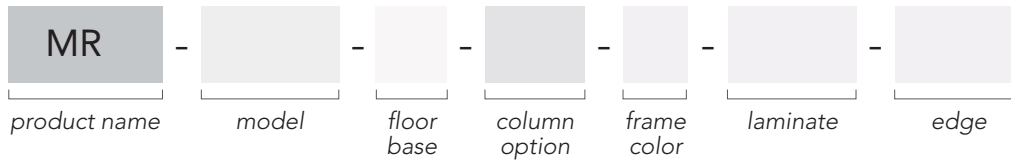





# worksurface and edge finishes

## worksurface finishes\*



**CZ** Canyon Zephyr



**DZ** Desert Zephyr



**TZ** Twilight Zephyr



**WN** White Nebula



**WT** White Tigris



**NE** Nickel EV

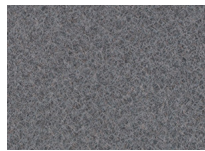

**CE** Carbon EV



**SE** Silicon EV



**BM** Birch Matrix

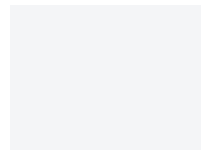

**DW** Designer  
White



**FG** Fashion Grey



**NS** North Sea



**KM** Kensington  
Maple

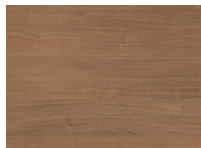

**RC** River Cherry

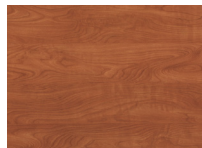

**WC** Wild Cherry

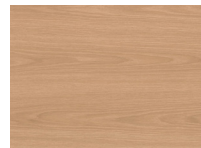

**NO** New Age Oak

## edge finishes

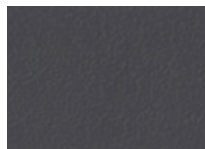

**CH** Charcoal



**LG** Light Grey



**DW** Designer  
White

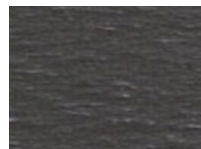

**GH** Graphite

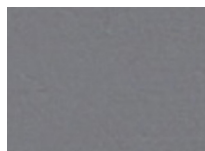

**NS** North Sea

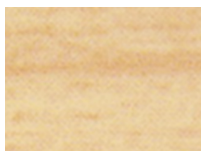

**FM** Fusion Maple

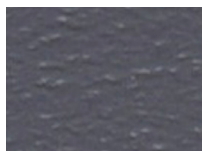

**ST** Storm

## frame colors

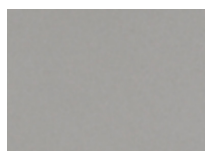

**S** Silver



**B** Black

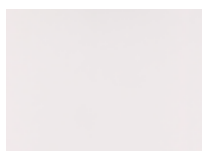

**W** White

\*Laminates reflected on this page are represented by Wilsonart, Nevamar and Formica. SiS Ergo is pleased to partner with these companies and others to offer the widest selection of laminates for your project.

Please contact us at [sales@sisergo.com](mailto:sales@sisergo.com) for specific or additional laminate options.

\*\* Additional powder coat frame colors are available with MOQ. If you would like us to match a color please specify it on pg. 31 when filling out the form.

# upgrades and accessories



## Upgrade to 3 Position Programmable Control Switch

# MS  
Programmable switch with 3 memory presets  
List Price: \$129



## Upgrade to Programmable Memory with Digital Control Switch

# DS  
Programmable switch with 3 memory presets and a digital height display.  
List Price: \$179

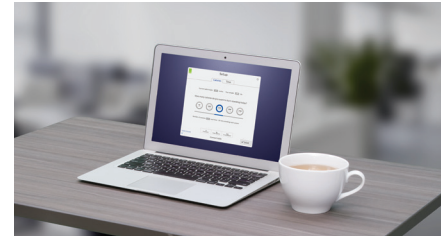

## Upgradeable Employee Wellness Kit

# WK  
MS or iOS program to adjust table, count calories and provide memory settings (Only available with SX and SE models)  
List Price: \$150



## Upgradeable Bluetooth Control Module for Table

# BT  
Receiver that will connect to table and adjust table with free downloadable app (only available with SX or SE tables)  
List Price: \$199

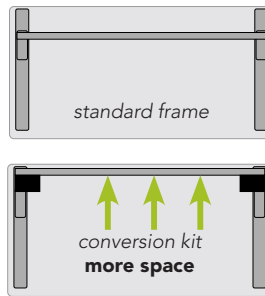

## Cantilever Conversion Kit

# 6699  
Maximizes undersurface clearance for mounted accessories like keyboard tracks  
List Price: \$129

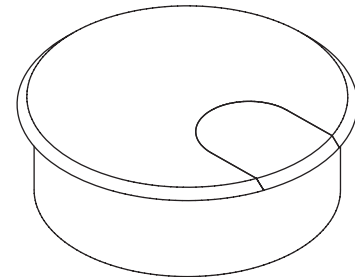

## Grommet

# R010097  
2.5" diameter  
List Price: \$3

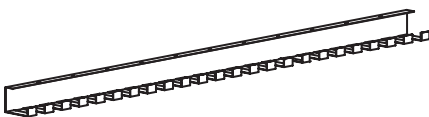

## Wire Management- 22.4" length

# 990103-8  
570 mm (22.4") length  
List Price: \$92



## Wire Management- 43.7" length

# 990102-8  
1,100 mm (43.7") length  
List Price: \$104



## Wire Management- 55.5" length

# 990101-8  
1,470 mm (55.5") length  
List Price: \$116





**CPU Holder**

# 990010

CPU holder for S Collection tables

List Price: \$139



**Single Monitor Desk Mount**

# VF-AT

Flexible movement with 3 points of articulation; all mounting hardware, bolt through, desk clamp mounting options included; can be upgraded to support additional displays

List Price: \$319



**Dual Monitor Desk Mount**

# VF-AT-D

Flexible movement with 3 points of articulation; all mounting hardware, bolt through, desk clamp mounting options included

List Price: \$529



**1" Ergo Casters**

# 8025

Set of 4 casters, locking/non-locking, hard wheel, 65 lbs. per caster, available for SXL, SEL and M Series products

List Price: \$119



**2" Ergo Casters**

# 8997

Set of 4 casters, locking, hard wheel, 110 lbs. per caster, available for all table frames

List Price: \$139

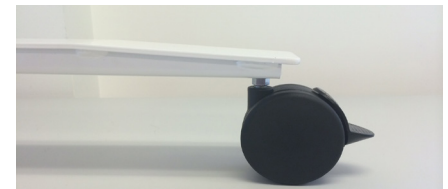

**3" Ergo Casters**

# 8999

Set of 4 casters, locking, hard wheel, 165 lbs. per caster, available for all table frames

List Price: \$149



**3" Casters**

# 8028

Set of 4 casters, locking/non-locking, soft wheel, 165 lbs. per caster, available for all table frames

List Price: \$149

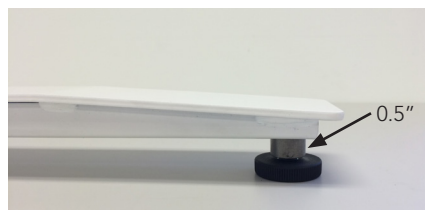

**Glide Spacers**

# R015139

Set of 2, 1" diameter, 0.5" height

List Price: \$39



**Power/Data/USB**

# SECL-3-USB-GW72

3 power outlets and 2 USB ports, clamp mount for tables ranging in thickness between 0.75" - 1.75", white

List Price: \$350

# customize

## design by the inch

SiS Ergo products are not limited to standard sizes and are available in 1 inch increments from 24 inches to 96 inches with surface depths starting at 18 inches. Tops can be shaped however you need them—including, but not limited to, designing around computer equipment or with cockpits to improve the user reach envelope.

## standard frame shapes

Choose from the common shapes below or request a custom configuration.

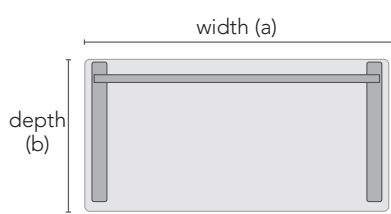

2 leg rectilinear

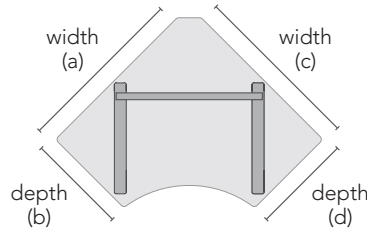

2 leg equal corner

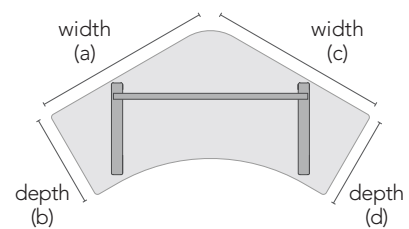

2 leg 120°

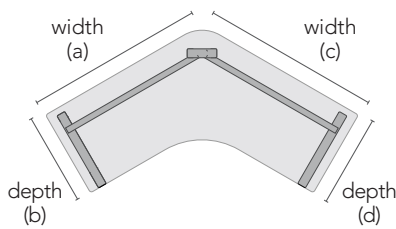

3 leg 120°

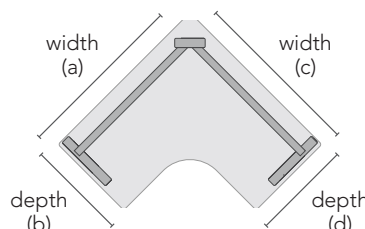

3 leg 90°

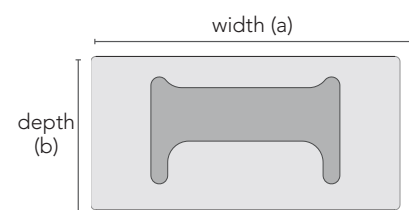

column rectilinear

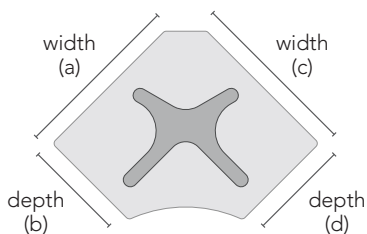

column corner

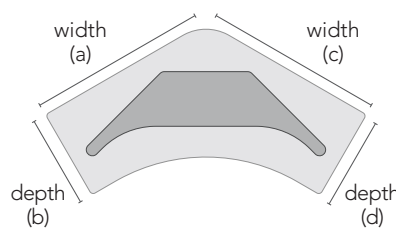

column 120°

## custom shapes

See our portfolio of custom orders and contact us to find a shape that meets your needs.



## sketch, scribble or digitally design

Simply send your plan to [sales@sisergo.com](mailto:sales@sisergo.com) or fax to (603) 434.8456, and we will provide you with a custom solution that fits your working environment.

## design your own table

Date  Dealer Name

Contact Email  Contact Phone

Project Name

Projected Quantity  Expected Delivery Date

### 1. select frame

Enhanced Electric (SX)  Standard Electric (SE)  Constantforce  Crank  Pin  
 Frame Only  Complete Table

### 2. select top shape *see page 20 for shape options*

2 leg rectilinear  2 leg equal corner  2 leg 120°  3 leg 120°  3 leg 90°  
 column rectilinear  column corner  column 120°  
 Other *Please Specify:*

### 3. specify top dimensions *width and depth for all sides see page 20 for measurement guide*

a:  b:  c:  d:

### 4. select frame color

Black (B)  White (W)  Silver (S)  Custom (*minimum quantities may apply*)

### 5. select switch option

Up/Down Control Switch (UD)  Non-digital Control Switch (MS)  Digital Control Switch (DS)

### 6. select surface laminate

Standard Laminate Color:

Custom Laminate Laminate Manufacturer:  Color Code:

### 7. select edge

Standard Edge 3mm PVC Color:

Custom Edge

### 8. add upgrades

3" Casters  Digital Control Switch  Grommet(s)  CPU Holder  Monitor Arm  
 Glide Spacers  Heavy-Duty Legs  Anti-Collision Legs  Keyboard Platform  
 Cantilever Conversion Kit

*Please send completed form to [sales@sisergo.com](mailto:sales@sisergo.com) or fax to 603.434.8456.*

# terms and conditions *effective June 1, 2015*

**Freight:** SiS-USA Inc. shall select the method of shipment, carrier, and routing in the 48 U.S. contiguous states. Normal LTL or truckload delivery is dock-to-dock and **Normal delivery hours are between 8 a.m. and 5 p.m. Monday through Friday.** All products shall be shipped "F.O.B. Shipping Point".

All orders shipping outside the 48 contiguous U.S. states shall be subject to additional freight that will be pre-paid and added to the invoice. Please contact [orders@sisergo.com](mailto:orders@sisergo.com) for a freight quote. The customer will be responsible for arranging customs clearance, applicable duties, and taxes shipping outside of the US.

SiS-USA Inc. will take reasonable efforts to meet delivery requests. All requests for carrier-guaranteed delivery times shall be considered and will include an additional fee, if accepted. This additional fee will be the maximum liability to SiS-USA Inc. if the carrier misses the guaranteed delivery time and a refund will be issued to customer.

All SiS-USA Inc. standard ground and guaranteed delivery times are exclusive but not limited to any additional costs associated with customer orders. Customer shall be responsible for, but not limited to, any or all the following costs:

- Expedited or air freight
- Special shipping or packaging methods
- Lift gates/forklift
- Delivery outside of normal hours
- Inside delivery
- Redelivery, notification, etc.
- Improper refusal of product
- Detention charges
- Street unloads
- Redirection of product

SiS-USA Inc. will pay for normal ground freight charges on any single release order shipping to a single destination within the 48 U.S. contiguous states for all accessories and orders containing 6 or more adjustable tables.

All single release orders containing 5 or less standard table frames or complete frame and top in this catalog will include a flat freight charge of \$99 per table to any of the 48 contiguous U.S. states. The following example will outline the net cost freight per table.

Order Qty.	Invoice Net
1	\$99
2	\$198
3	\$297
4	\$396
5	\$495

\*Any custom table or product not reflected in this catalog will receive an actual freight cost and can be obtained by customer service at [orders@sisergo.com](mailto:orders@sisergo.com)

#### **Lead Time:**

- All standard products will receive ship dates 4 - 6 weeks from order acknowledgement.
- Additional charges may apply for expedited shipping, if requested.

(Lead time for custom orders are quoted separately.)

This price list and these terms supersede all previous price lists and terms. These prices and terms are subject to change without notice.

**Terms of Payment:** Terms of payment will be established based on the credit rating and credit information provided by and for specific customers. New dealers require credit references, valid tax-exempt or resale certificate, when applicable. Orders are invoiced at time of shipment. Approved credit terms are net 30 days. A 1.5% late charge on unpaid

balances will be applied per month until balance is paid in full, or the highest rate permitted by law plus all collection costs, including reasonable attorney's fees and expenses.

**Credit Cards:** AMEX, MasterCard and Visa payment accepted. A 3.5% administrative fee will be added to the invoice total for all credit card payments.

**Order Acceptance:** All orders must be submitted via fax at (603) 434.8456 or email to [orders@sisergo.com](mailto:orders@sisergo.com). The Order Confirmation is the final expression of the contract between the Customer and SiS-USA Inc. Signatures on a quote do not qualify as an approved authorized order. All orders must include the following:

- PO issued to: SiS Ergo 55 Wentworth Ave Londonderry NH 03053
- Order date: date PO was issued
- PO number including any customer specific identifier such as a SiS Ergo SPA
- Bill to: complete legal name, address, telephone/fax number/e-mail
- Ship to: complete legal name, address, contact name, contact phone number
- Authorized purchasing agent signature
- Total order including quantity, list & net price, extended price, any additional service or fees

**Order Acknowledgments:** Each order is acknowledged within 1-2 business days from receipt of order. Any discrepancy or error must be corrected and sent to SiS within 2 business days. All acknowledged orders are considered final documents with an estimated ship date.

**Custom Orders:** All custom orders must accompany a formal SiS quote with drawing if necessary. Each order must accompany a SiS drawing and is subject to additional charges, MOQ, & extended lead times.

**Order Changes and Cancellations:** Purchase orders may not be changed or cancelled, in whole or in part, without prior written consent of SiS-USA Inc. Changes or revisions must clearly be indicated on the new PO and may affect delivery dates. Expenses incurred because of changes will be charged to the customer. In the event of cancellations, customer will be liable for reasonable cancellation charges established by SiS-USA Inc. Orders for customized products, custom finishes and customer's Own Material (COM) may not be cancelled. All custom orders are final and non-refundable.

**Returns:** All custom products are non-refundable. The return of (non-custom) products without a written authorization by SiS-USA Inc. shall not be accepted. Requests for authorized returns must be submitted to SiS-USA Inc. within 60 days of receipt of order. If SiS-USA Inc. agrees to repurchase the unopened product pursuant to a valid RGA, the customer must return the products freight prepaid to SiS-USA Inc. The returned products shall be subject to a 20% of list restocking charge. All returned products must be unused and in original condition, packaging, and returned within 30 days of issued valid RGA from customer service.

**Loss, Damage or Delay:** SiS-USA Inc. shall not be liable for any loss, damage or delay resulting from forces beyond its reasonable control including fire, flood, strike or other labor difficulty, act of God, embargo, fuel or energy shortage, transportation delay, inability to obtain labor, materials, failure of suppliers to meet their contractual obligations or due to any cause beyond reasonable control. In the event of a performance delay SiS-USA Inc. reserves the right to extend the date of delivery or time of completion by a period of time necessary to overcome the delay in a manner it deems reasonable or cancel any purchase order.

---

**Freight & Shortage Claims:** Risk of loss passes to the customer upon SiS-USA Inc. delivery of the product to the carrier (F.O.B.). If the carrier damaged the product while in transit, the customer has sole obligation of seeking any recourse against the appropriate carrier. Claims against SiS-USA Inc. for shortages and errors must be made within seven (7) days of the date of delivery.

**External Damage Claim Procedure:**

1. The customer or customer's agent must note product shortages and damage on delivery receipts at the time of receipt.
2. If the carrier damaged the product while in transit, the customer has sole obligation of rejecting or refusing damaged items.
3. Contact customer service at orders@sisergo.com within (2) business days and provide them with all supporting documentation and advise them of the filed claim.

**Concealed Damage Claim Procedure**

1. The customer or customer's agent must contact freight carrier to report damage within (10) business days from receipt of order
2. Customer must retain original packaging and all associated shipping documentation
3. Contact SiS customer service at orders@sisergo.com. Provide rep with all documentation supporting your filed claim along with PO#, freight carrier and all packaging materials.

**Warranty:** SiS-USA Inc. warrants all table frames in the S collection and M series to be free of defects in materials and craftsmanship for the life of the product to the original customer. All electric motors, controls, actuators and springs receive a full five-year warranty based on normal usage (consisting of a 5 day work week at 8 hours per day) during the warranty period. With prompt written notice, SiS-USA Inc. shall replace, at its option and cost, any products that fail to conform to the warranty with the exception of items listed below.

**This warranty does not apply to:**

- Damage caused by a carrier.
- Labor charges.
- Normal wear and tear.
- Defects caused by improper installation.
- COM or other third party materials applied to the products.
- Products subjected to improper use and conditions.
- Damage resulting from misuse, negligence, accident or alteration.

**Please note that any invoice submitted to SiS-USA Inc. for warranty replacement or labor will be invalid unless replacement parts have been preauthorized in writing by SiS-USA Inc.**

## *manufacturing process & specifications*

**Meeting Standards:** SiS-USA Inc. workstations and accessories are designed to meet the most stringent worldwide ergonomic criteria. Combined with ergonomic seating and end-user training, occupational related cumulative trauma disorders and work interruptions are decreased and productivity is increased.

**ADA:** Tables with top widths of 48" or greater that have a leg frame with an unobstructed inside width of 30" or more meet ADA accessibility requirements

**ANSI/HFES, OSHA, nSC, GS & EC:** 8 gauge CRS (Feet), 16 gauge CRS (Uprights), 13 gauge CRS "J" channel (Underframe), CRS (Cold Rolled Steel) tested to DIN 2394/2395

**Base:** 8 gauge CRS (Feet), 16 gauge CRS (Uprights), 13 gauge CRS "J" channel (Underframe), CRS (Cold Rolled Steel) tested to DIN 2394/2395

**Welds:** Seam MIG Welds

**Standard:** ANSI/AWS A2.4-86

**Tops:** Particle board core, laminate cover, phenolic backer, predrilled & include metal threaded inserts. All tops according to DIN 68765 and ANSI standards

**Fire rated:** According UL 723 (USA) and Baustoffklasse BI (BRD)

**Reflection:** Luminance-tested according to DIN 67530 using a reflectometer measurement

**Laminate:** .05" thick decorative laminate

**Core:** 1.00" - 1.12" thick, 45 lb density chip core substrate. Contains nominal formaldehyde levels below 0.02 parts per million per Raffael which is below marginal value according to DIN 4554

**Backer Sheet:** .027" thick phenolic backer

**Shipping:** KD (Knocked Down)

**F.O.B.:** Shipping Point, freight prepaid and charged back if applicable

**Environmental Report:** It is SIS-USA Inc.'s policy to continuously reduce the environmental impact of products and processes. We seek to achieve this through better use of raw materials and energy and by optimizing our production processes.

In practice, SIS-USA Inc. environmental policy involves:

- Actively protect and maintain the environment in the vicinity of the company.
- Prioritizing environmental considerations when redeveloping products through choice of materials and processes.
- Including our employees in the environmental process to increase motivation to create good workplaces and environmentally friendly products.
- Optimize material usage to reduce waste and environmental impact.



SiS Ergo

55 Wentworth Avenue

Londonderry, NH 03053 USA

toll free: (800) 374. 7438

phone: (603) 432.4495

fax: (603) 434.8456